

Article number: 20908STM2415AC

Description: E+G Threaded plug DIN 908-ST-M24x15-AC

Measures

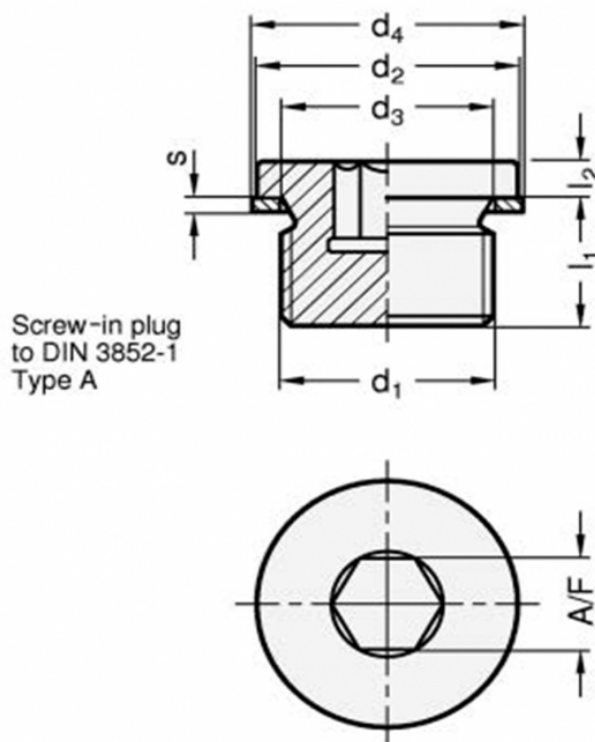

A/F	= 12
d1	= M24x15
d2h14	= 29
d3	= 24.3
d4	= 29
l1	= 14
l2	= 4
s	= 2

Weight in (g) = 60